



Product Information

Interactive PDF

INTERNET-LINK 

VIDEO/ANIMATION 

Release 1.0

Axio Vert.A1

Microstructural and Structural Analysis:
A Question of Contrast.



We make it visible.

All Contrasts. No Compromises.

Axio Vert.A1

Microstructural and
Structural Analysis:
A Question of Contrast.

- › **In Brief**
- › The Advantages
- › The Applications
- › The System
- › Technology and Details
- › Service

Axio Vert.A1 is a compact, inverted microscope that brings you big insights. You can examine large, heavy samples, using a wide range of classic and advanced contrast methods. You switch easily between brightfield, darkfield, DIC, C-DIC, fluorescence and polarization contrast in reflected light. In transmitted light, use brightfield, polarization and phase contrast. Axio Vert.A1 lets you choose the best methods – without compromise. Or you might decide to combine several contrast methods for the maximum amount of information.

The 5x encoded nosepiece turret recognizes a change of objectives automatically. It also enables the use of a light manager to save and recover light intensity values. You can quantify your structure efficiently, evaluate the properties and quality of your materials. Gain valuable new understanding and optimize preparation or production processes. And then take appropriate measures.



Axio Vert.A1: Simpler. More intelligent. More integrated.

Axio Vert.A1

Microstructural and
Structural Analysis:
A Question of Contrast.

- › In Brief
- › **The Advantages**
- › The Applications
- › The System
- › Technology and Details
- › Service

Fast Imaging with a Wide Range of Objectives

You need a variety of objectives for your applications. Select the appropriate magnification at all times with the Axio Vert.A1 5x encoded nosepiece turret. The encoding allows Axio Vert.A1 to automatically recognize your objective, which saves time and eliminates a possible source of error.



Contrast Methods for All Details

Axio Vert.A1 provides all common contrast methods: the 4x reflector turret switches quickly and easily in reflected light between brightfield, darkfield, DIC, C-DIC, fluorescence and polarization contrast, allowing you to examine anisotropic materials such as magnesium and aluminum. Switch to transmitted light illumination and you work with brightfield, polarization or phase contrast.



Reproducible Measuring and Comparing

The field of view of 23 allows you to gain a quick, comprehensive overview of your sample at first sight. A range of reticles and structure comparison disks is available for measuring and counting. In addition, AxioVision Software by Carl Zeiss offers you a powerful range of modules such as grain size, phase analysis, layer thickness and interactive measurement for your investigations.

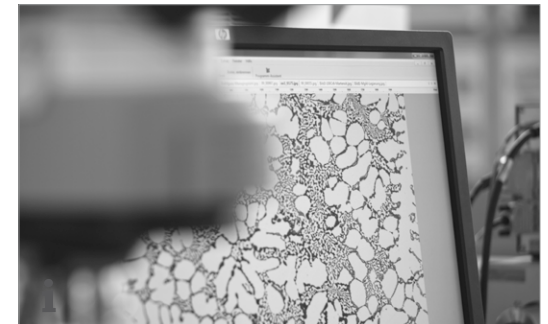

Your Insight into the Technology Behind It

Axio Vert.A1

Microstructural and
Structural Analysis:
A Question of Contrast.

- › In Brief
- › The Advantages
- › **The Applications**
- › The System
- › Technology and Details
- › Service

Use Eco Mode For Greater Safety

In Eco mode Axio Vert.A1 automatically switches off whenever you stop using the microscope for longer than 15 minutes. This prolongs the service life of your lamps and saves energy. If you prefer, you can simply switch the Eco function off and return to continuous operation.



The USB Port Offers Even More Reliability

Because Axio Vert.A1 links directly to your PC, you can acquire data and continue working seamlessly. Your microscope will be using the standard protocols of your computer – no extra drivers needed.



Tailored Precisely to Your Applications

Axio Vert.A1

Microstructural and Structural Analysis:
A Question of Contrast.

› In Brief

› The Advantages

› **The Applications**

› The System

› Technology and Details

› Service

Typical applications, typical samples	Task	Axio Vert.A1 provides
Metallography / Materialography	Analysis of structure (e.g. phases, grain sizes, texture, precipitates) and structural defects (e.g. inclusions, porosities, voids, cracks)	Evaluation and documentation via AxioCam and AxioVision
	Measurement of layer thicknesses and geometric properties (e.g. electrode thicknesses)	Inverse design Field number 23
	Analysis of dark samples with minor reflection differences	Use of immersion objectives
	Analysis of anisotropic samples (e.g. grain size of aluminum alloys by Barker etching, zinc alloys, graphite, titanium alloys, magnetic materials)	Polarization contrast Use of high N.A. objectives
	Fast switching between contrast methods	All common contrast methods Fast switching of P&C reflector modules via 4x reflector turret
	Verification of measurement capability; no mix-up of scaling	Encoded 5x nosepiece turret for automatic recognition of selected magnification Light manager recognizes illumination intensity
Polymers	Thin section samples: assessment of synthetic recyclates; analysis of pigments, lacquers, carbon blacks, fibers or fillers in transmitted light	Optional carrier for transmitted light illumination
	Thin section samples: Spatial distribution of polymer mixtures	Optional carrier for transmitted light illumination Phase contrast
	Thin section samples: examination of crystallinity differences, structural differences, thermal damage, processing influences, cavities, inclusions and internal mechanical tensions of part-crystalline polymer materials	Optional carrier for transmitted light illumination Polarization contrast
	Fast switching between contrast methods	All common contrast methods Fast switching of P&C reflector modules via 4x reflector turret
	Verification of measurement capability; elimination of scaling errors	Encoded 5x nosepiece turret for automatic recognition of selected magnification Light manager recognizes illumination intensity
Building materials / Betonography	Thin section samples: structural analysis, identification of specific phases and minerals, and of crystalline structures	Optional carrier for transmitted light illumination Polarization contrast
Asbestos fibers	Thin section samples: Identification of asbestos fibers	Optional carrier for transmitted light illumination Polarization contrast
	Thin section samples: quantity and particle size distribution of asbestos fibers	Optional carrier for transmitted light illumination Phase contrast

Axio Vert.A1 at Work

Axio Vert.A1
Microstructural and
Structural Analysis:
A Question of Contrast.

- › In Brief
- › The Advantages
- › **The Applications**
- › The System
- › Technology and Details
- › Service

Use the contrast method of reflected light brightfield to analyze the microstructures of etched surfaces. Recognizing grain boundaries, you can draw conclusions on grain sizes, phases and structural constituents. See colors and pigments. Detect impurities and structural constituents, such as graphite in cast iron, prior to etching.

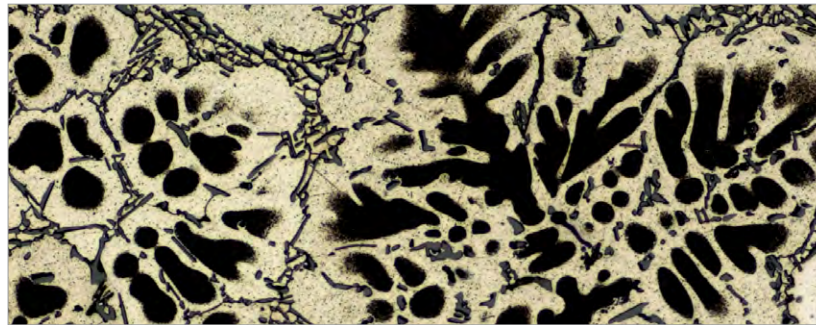

Aluminium alloy, 100x, brightfield

Use the polarization contrast to analyze the structure of anisotropic materials, such as magnesium, aluminum, bronze and brass. In polarized light, the individual grains of crystal lattice will show their characteristic color.

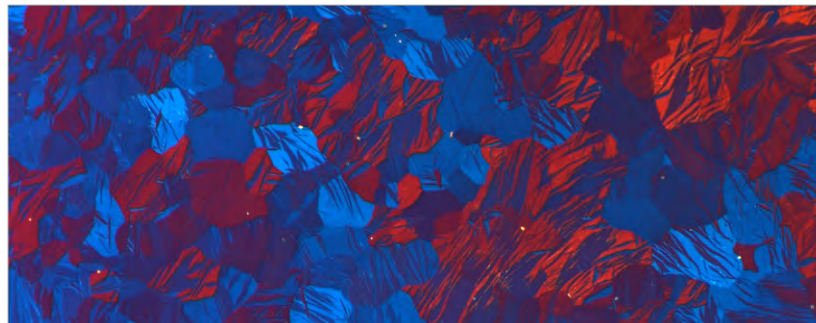

Pure magnesium, 100x, polarization

(Photo courtesy: Allied High Tech Products Inc.)

In reflected light darkfield, mechanical surface faults such as fracture sites, pores and inclusions show up just as well as cracks, scratches and cavities. You can assess the surface quality of processed work pieces precisely, and make out grain boundaries on etched cuts just as easily.

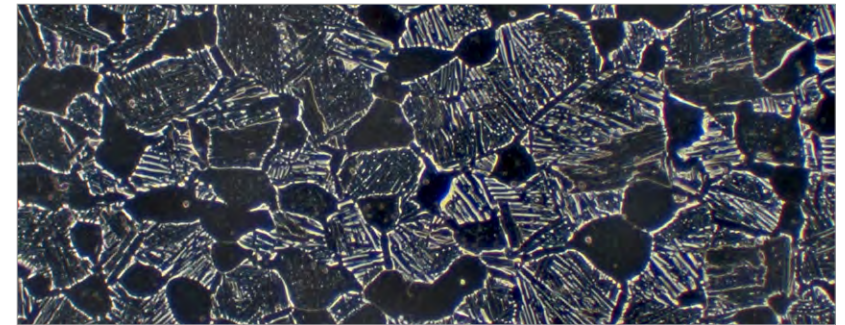

Alpha-Beta Ti, 500x, darkfield

(Photo courtesy: Allied High Tech Products Inc.)

The Differential Interference Contrast (DIC) lets you detect tiny structural differences in height with particular sensitivity. Differences in height, whether in the form of natural differences or artifacts produced by preparation, take on a 3D effect as relief-like structures.

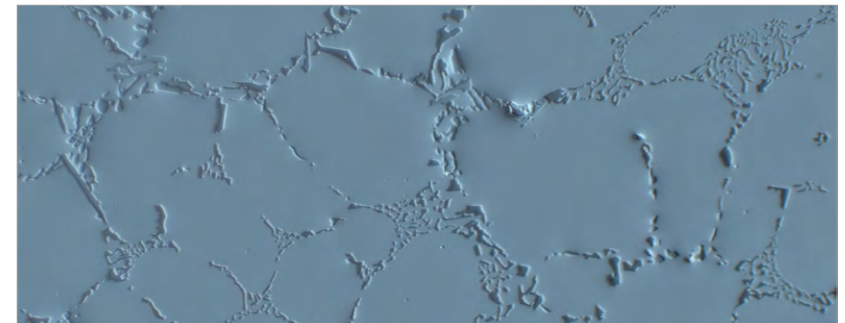

Cast aluminium, 500x, C-DIC

(Photo courtesy: Allied High Tech Products Inc.)

Axio Vert.A1: Your Flexible Choice of Components.

Axio Vert.A1

Microstructural and
Structural Analysis:
A Question of Contrast.

- › In Brief
- › The Advantages
- › The Applications
- › **The System**
- › Technology and Details
- › Service

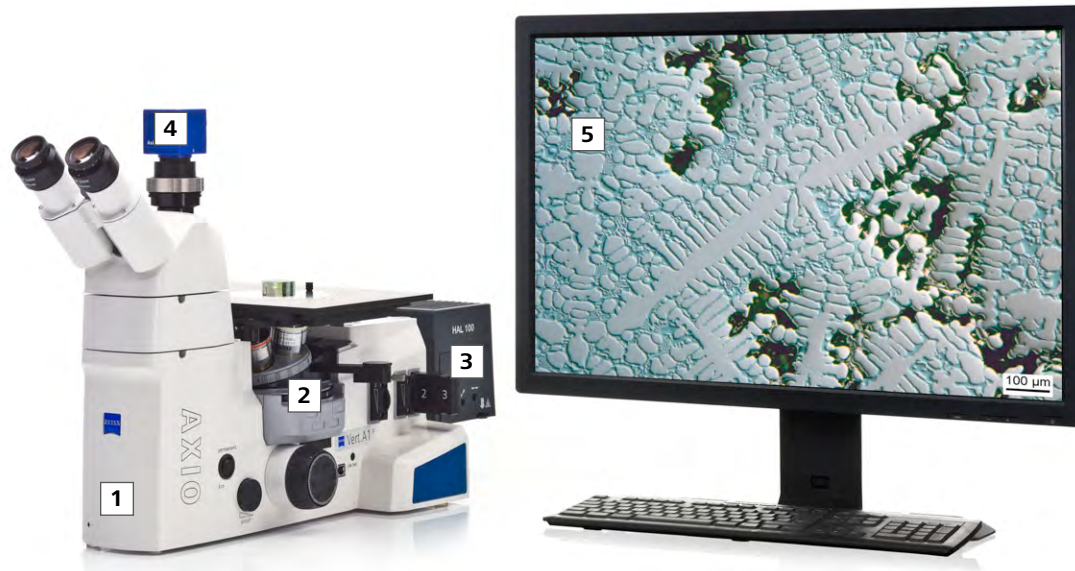

1 Microscope

- Design: inverted stand
- Freedom to examine different specimens and large samples

2 Objectives

Recommended classes for best resolution:

- Reflected light:
 - EC-EPIPLAN
 - EC Epiplan-NEOFLUAR (also as LD variants)
- Transmitted light:
 - N-ACHROPLAN Pol
 - Plan-NEOFLUAR Pol

3 Illumination

- VisLED (LED)
- Hal 100 (halogen)

4 Cameras

Recommended cameras:

- AxioCam ERc 5s
- AxioCam ICc 1
- AxioCam ICc 3
- AxioCam MRC
- AxioCam MRm

5 Software

- AxioVision LE: image acquisition, image processing, image analysis and documentation

Recommended AxioVision modules:

- MosaiX (image acquisition scanning stage)
- Graphite, Grains, Multiphase, NMI, Particle Analyzer Projects, Comparative Diagrams, Interactive Measurement (image analysis)

Axio Vert.A1: System Overview

Axio Vert.A1

Microstructural and
Structural Analysis:
A Question of Contrast.

› In Brief

› The Advantages

› The Applications

› The System

› Technology and Details

› Service

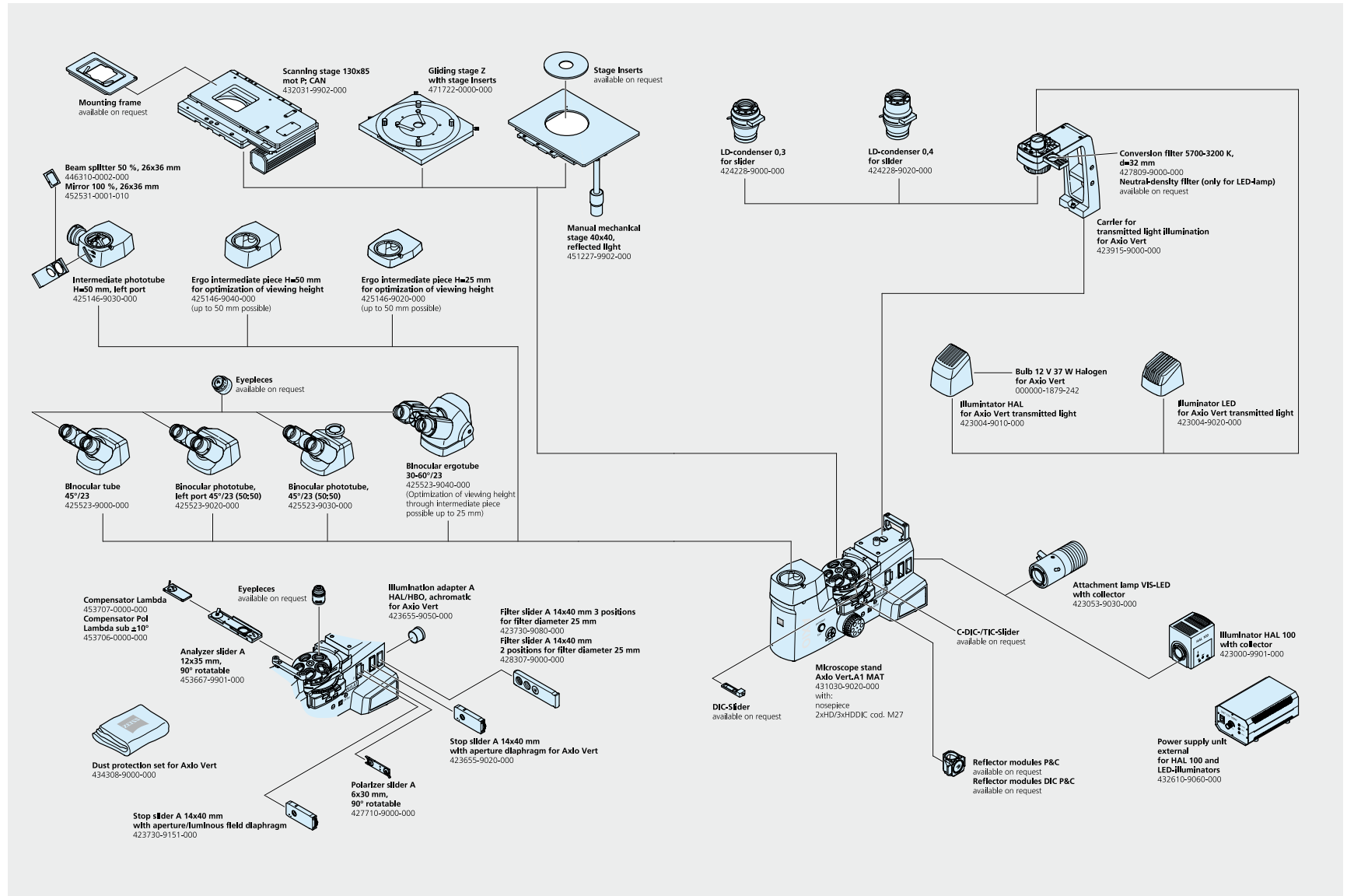

Technical Specifications

Axio Vert.A1
 Microstructural and
 Structural Analysis:
 A Question of Contrast.

- › In Brief
- › The Advantages
- › The Applications
- › The System
- › **Technology and Details**
- › Service

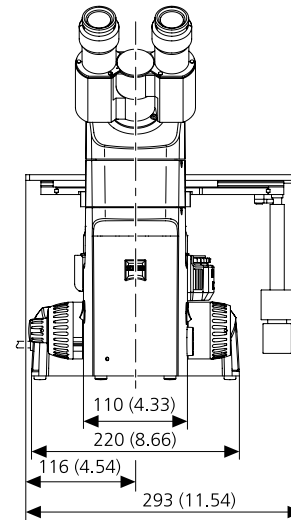
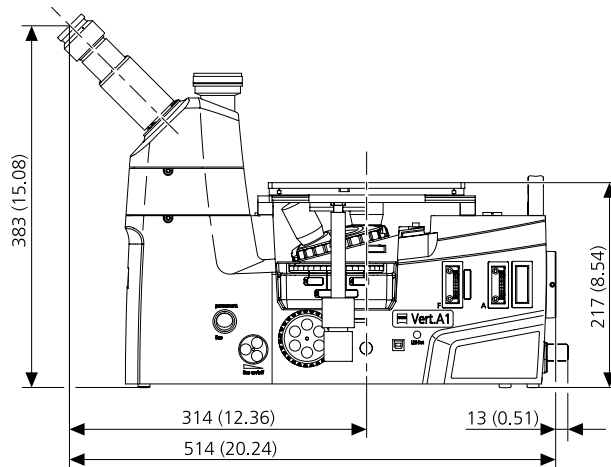

Microscope

Stand	Inverted manual reflected light microscope Optional: carrier for transmitted light illumination
Dimensions (W x D x H)	220 x 560 x 355 mm
Weight	10.3 kg
Eyepieces	Field number 23 (W-PI 10x/23 br foc) diameter: 30 mm

Axio Vert.A1

Microstructural and
Structural Analysis:
A Question of Contrast.

- › In Brief
- › The Advantages
- › The Applications
- › The System
- › **Technology
and Details**
- › Service

Objectives

Objective turret	5 position H-D, DIC (encoded)
------------------	-------------------------------

Illumination

Hal 100 (Halogen)	Output: 100 W, controllability: continuous, ≤ 1.5 to 12 V
-------------------	--

VIS-LED (LED)	Output: 20 W, voltage: 0 to 12 V DC, LED risk group 1 acc. to DIN EN 62471:2009, wavelength: 400 – 700 nm
---------------	---

Contrast method

Reflected light	Brightfield, darkfield, DIC, C-DIC, fluorescence, polarization
-----------------	--

Transmitted light	Brightfield, polarization, phase contrast
-------------------	---

Reflector turret	4x reflector turret for Push&Click reflector modules
------------------	--

Accessories

Tubes	Binocular tube 45°, 23 Binocular phototube, left 45°, 23 (50:50) Binocular phototube, 45°, 23 (50:50) Binocular ergotube, 30° - 60°, 23
-------	--

Spacer tubes	Photo spacer tubes, H=50 mm, left Ergo adapter, H=25 mm Ergo adapter, H=50 mm
--------------	---

Stages	Mechanical stage 40 x 40 with various stage diaphragms Gliding stage including stage inserts Scanning stage 130 x 85, mot P, CAN with various holders
--------	---

Axio Vert.A1

Microstructural and
Structural Analysis:
A Question of Contrast.

- › In Brief
- › The Advantages
- › The Applications
- › The System
- › **Technology
and Details**
- › Service

Operational data

Area of use	Closed spaces
Protection class / protection type	I, IP 20
Electrical safety	acc. to DIN EN 61010-1 (IEC 61010-1) allowing for CSA and UL specifications
Overvoltage category	II
Radio interference suppression	acc. to EN 55011 Class B
Interference immunity	acc. to DIN EN 61326-1
Power supply	100 to 240 V AC \pm 10 %
Power frequency	50 to 60 Hz
Power consumption internal mains adapter	max. 80 VA

Fuses acc. to IEC 127

Stand Axio Vert.A1	T 3.15 A/H, 5x20 mm
Ballast for Hal 100	T 5.0 A/H, 5x20 mm

Environmental conditions

Transport (in packaging)	Permissible ambient temperature	-40 to +70 °C
	Permissible relative air humidity (no condensation)	max. 75 % at 35 °C
Storage	Permissible ambient temperature	+5 to +40 °C
	Permissible relative air humidity (no condensation)	max. 75 % at 35 °C
Operation	Permissible ambient temperature	+5 to +35 °C
	Permissible relative air humidity (no condensation)	max. 75 % at 35 °C
	Max. altitude of installation site	max. 2000 m
	Atmospheric pressure	800 hPa to 1060 hPa
	Pollution degree	2

Count on Service in the True Sense of the Word

Axio Vert.A1

Microstructural and
Structural Analysis:
A Question of Contrast.

- › In Brief
- › The Advantages
- › The Applications
- › The System
- › Technology and Details
- › **Service**

Your results really matter to us: we want you to get the best you expect from your microscope. Depend on Carl Zeiss for everything you need: technology, software, advice and service. We stay with you long after installation of your microscope on site. Carl Zeiss specialists will continue to maintain your systems, repair them, supply spare parts and much more. Just call us: we are always here for you.

Total Protection with Your Carl Zeiss Service Contract

It's the safe and practical way to preserve the efficiency of your microscope system. Our service contract protects you against expensive downtime.

Preventive Maintenance Plus Optimizes Performance

Our specialists will maintain and tune your system at regular intervals. You get valuable advice and comprehensive answers to any and all questions. We will also keep you right up to date on developments in your field of application.

The Standard Contract Also Includes Repairs and Support

In addition to all the services of Preventive Maintenance Plus, the standard contract covers all repair and support services. The only costs you will ever pay are for replacement components. Another important aspect of the standard contract is installation of software updates – your system will always be running the latest software version.

The Premium Contract Covers Spare Parts Too

Opt for the premium contract and you will have all services of the standard contract, plus free spare parts. This means you can predict your running costs precisely – and budget for them.

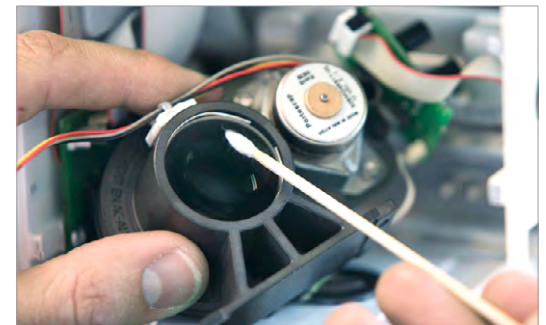

We are here for you:

www.zeiss.com/microservice

The moment technology provides
you with a result the first time.

This is the moment we work for.

Axio Vert.A1

Microstructural and
Structural Analysis:
A Question of Contrast.

- › In Brief
- › The Advantages
- › The Applications
- › The System
- › Technology and Details
- › Service



Axio Vert.A1

Microstructural and
Structural Analysis:
A Question of Contrast.

- › In Brief
- › The Advantages
- › The Applications
- › The System
- › Technology and Details
- › Service



facebook.com/zeissmicroscopy



twitter.com/zeiss_micro



youtube.com/user/zeissmicroscopy



Carl Zeiss MicroImaging GmbH

Carl-Zeiss-Promenade 10
07740 Jena, Germany

Industrial
E-Mail: micro@zeiss.de
www.zeiss.com/axiovert-mat



We make it visible.